

Saffire LX-P & Saffire EVO LZ-P

HAGAR 4500 exit door preparation

NOTES:

- FOR EXIT DEVICE AND MORTISE LOCK CUT-OUT REFER TO EXIT DEVICE MANUFACTURER INSTALLATION INSTRUCTIONS.
- BACKSET SHOWN FOR REFERENCE ONLY, ADJUST BACKSET TO EXIT DEVICE MANUFACTURER INSTALLATION INSTRUCTIONS. BACKSET TO BE ADJUSTED TO LOW AND HIGH BEVEL DOOR EDGE AS PER BACKSET ADJUSTMENT TABLE.
- DIMENSIONS ARE SYMMETRICAL ABOUT \varnothing UNLESS OTHERWISE NOTED.
- FOR SURFACE MOUNT VARIANTS PLEASE REFER TO IP-516418-15 FOR THE PLACEMENT OF HOLE 0.750" & CABLE GROOVE 0.250". HOLES 2x0.250" NOT REQUIRED.
- GROOVE TO BE DONE ONLY IN SOLID DOORS. TO PASS WIRES INSIDE THE DOOR FOR HOLLOW DOORS.
- REFER TO SPECIFIC TOLERANCES TABLE FOR DIMENSIONS MARKED WITH #.
- DRAWING IS NOT TO SCALE.
- DIMENSIONS ARE IN INCHES [mm].

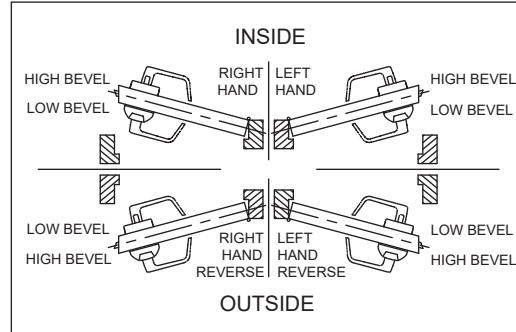

DIMENSIONS = IMPERIAL/IMPÉRIAL [MILLIMETER / MILLIMÈTRE]
 3D FILE GOVERNS ALL UNSPECIFIED DIMENSIONS & GENERAL TOLERANCES APPLY / LES DIMENSIONS NON SPÉCIFIÉES SONT DÉFINIES PAR LE FICHIER 3D ET LES TOLÉRANCES GÉNÉRALES S'APPLIQUENT
GENERAL TOLERANCE, UNLESS OTHERWISE SPECIFIED / TOLÉRANCES GÉNÉRALES, SAUF SI SPÉCIFIÉ AUTREMENT

THREAD CLASS / FILET FINISH / FINI
 SAE: 2A-2B ISO: 6g / 6H
 ANGLE: $\pm 1^\circ$
 CHAMFER / CHANFREIN: $\leq \pm 5^\circ$

BACKSET ADJUSTMENT FOR 3° BEVEL DOOR		
DOOR THICKNESS DIMENSION X	BACKSET ADJUSTMENT DIMENSION Y	
1.25" [31.8mm]	.032" [0.81mm]	
1.50" [38.1mm]	.039" [1.00mm]	
1.75" [44.5mm]	.046" [1.17mm]	
2.00" [50.8mm]	.052" [1.32mm]	
2.25" [57.2mm]	.059" [1.50mm]	
2.50" [63.5mm]	.065" [1.65mm]	
2.75" [69.9mm]	.072" [1.83mm]	

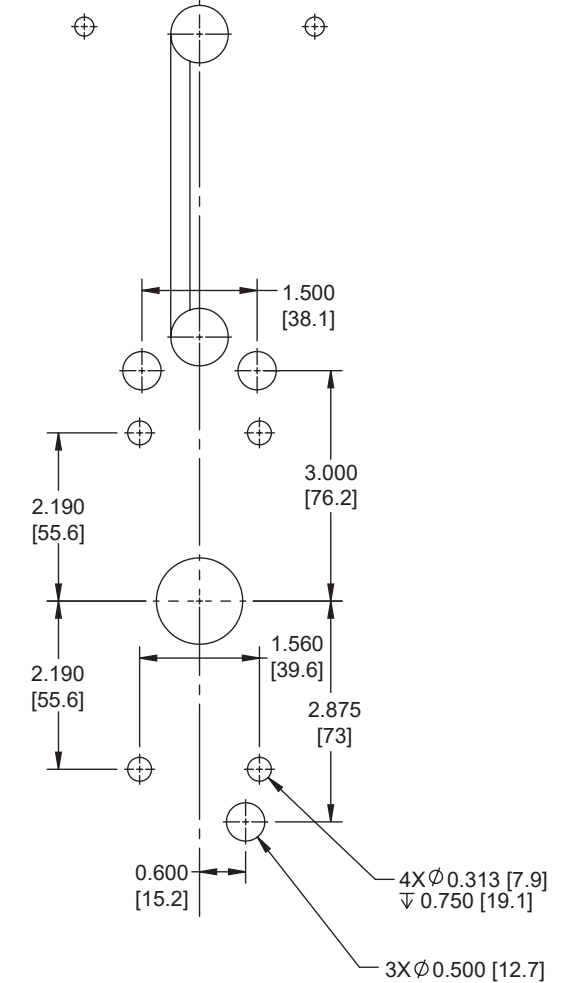
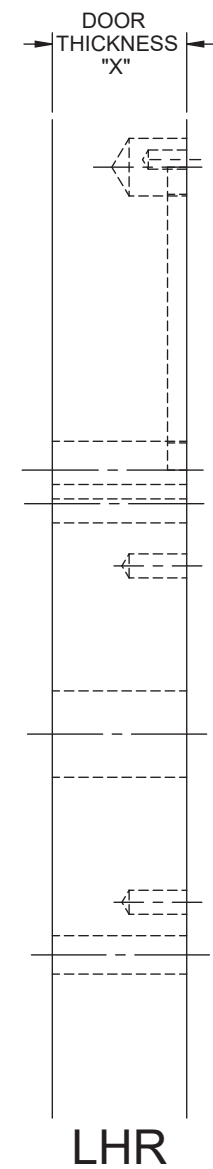
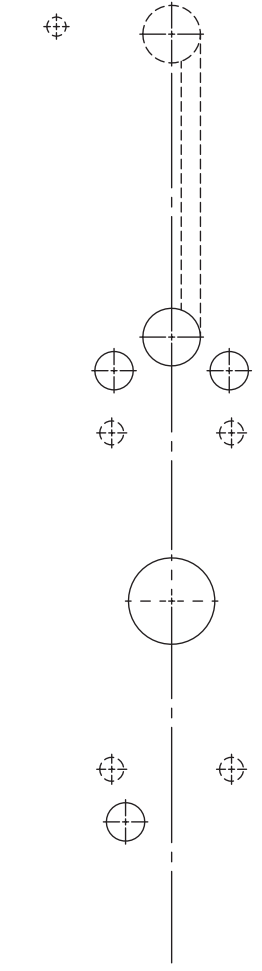
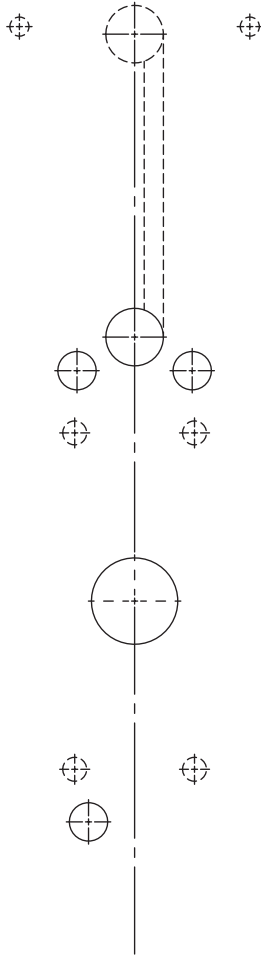
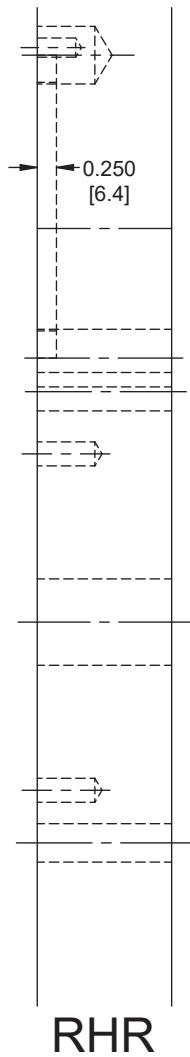
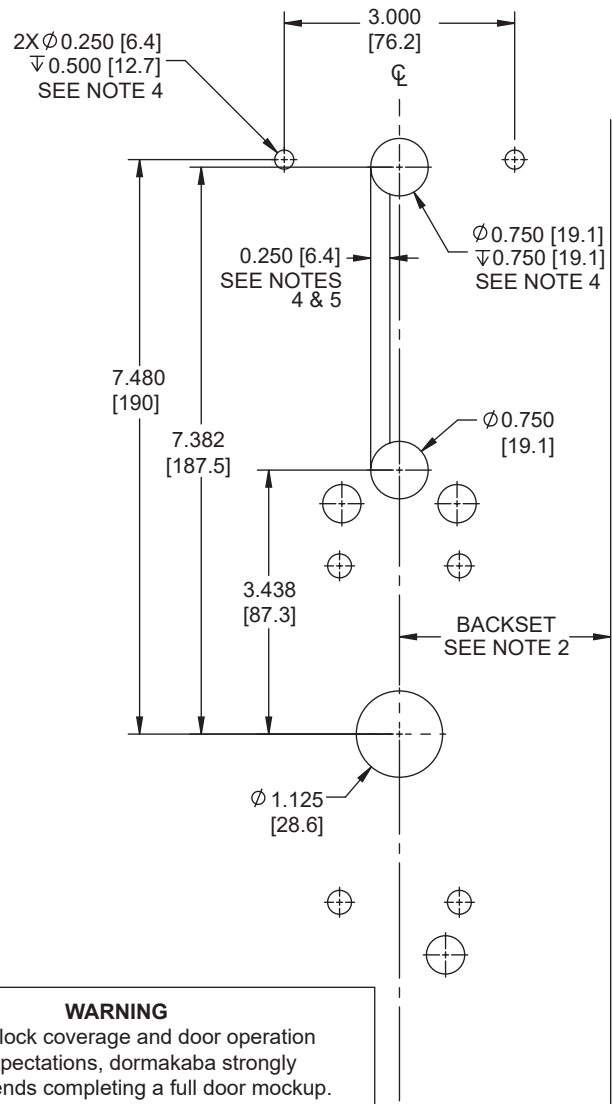

SPECIFIC TOLERANCES	
DISTANCES	$\pm .030$ [0.75]
HOLES \varnothing	$\pm .010$ [0.25]
DIMS MARKED #	+ .030 [0.75] - .000 [0.00]

WARNING

- To verify lock coverage and door operation meets expectations, dormakaba strongly recommends completing a full door mockup. This will ensure that all necessary products and parts for a successful installation are included.
- Always validate that you have selected the correct template for specific lock model being installed. The same lock model can be offered with different locking device options.
- Drawing is not to scale. Measurements are for reference only. Not a drilling template.
- If you have any questions, please contact your local sales representative or authorized reseller.